

1850nm Polarization Maintaining Isolator (PMIS)

Features

- Wide Operating Wavelength
- High Isolation & High PER
- Telcordia GR-1221 Compliant
- Available for Both Axes Pass or Fast Axis Block

Application

- PM Fiber Amplifier
- Fiber Laser
- Surgical Equipment



Specifications

Parameters	Unit	Single Stage	Dual Stage
Center Wavelength	nm	1850	
Peak isolation	dB	35	48
Min Isolation ($\lambda c \pm 15\text{nm}, 23^\circ\text{C}$ all sop)	dB	23	38
Typ. IL ($\lambda c \pm 20\text{nm}, 23^\circ\text{C}$ all sop)	dB	0.60	0.70
Insertion Loss ($\lambda c \pm 20\text{nm}, -5 \sim +70^\circ\text{C}$ all sop)	dB	≤ 0.70	≤ 0.80
PER	Both Axes Pass	dB	≥ 20
	Fast Axis Blocked	dB	≥ 23
Return Loss (Input / Output) (RL)	dB	$\geq 60/55$	$\geq 60/55$
Fiber Type		PM1550, PM1950, PM2000,	
Max Power Handling CW	mW	500	
Operating Temperature	$^\circ\text{C}$	$-0 \sim +75$	
Storage Temperature	$^\circ\text{C}$	$-40 \sim +85$	

Above data test at room temperature without connectors. With connectors, IL+0.3dB, RL-5dB, PER-2dB.

Default FC connector key width 2.02mm (narrow key), 2.12mm (wide key) available on request.

Typical Spectrum

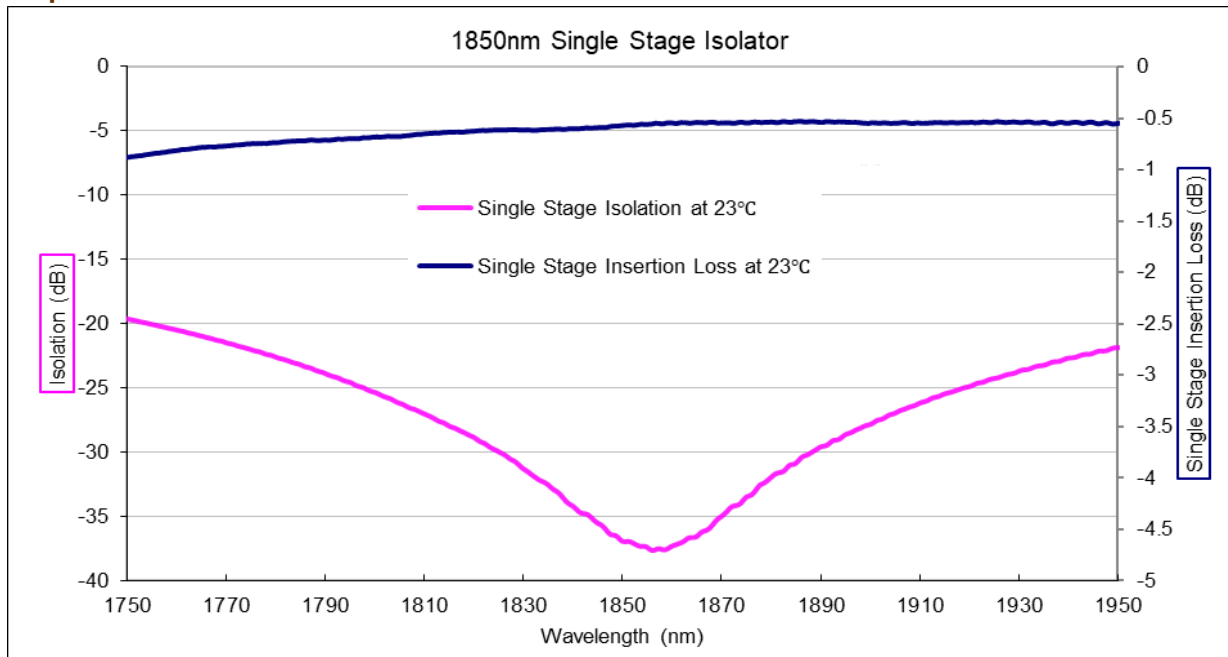

Package Information

Fiber Length	1m, others on request		
Pigtail Type	250 μm Bare Fiber	900 μm Loose Tube	2mm/3mm Loose Cable
Dimensions(mm)	$\phi 2.5 \times 25, \phi 3 \times 25, \phi 3 \times 30, \phi 5.5 \times 35,$	$\phi 5.5 \times 35, 90 \times 16 \times 9$	$\phi 5.5 \times 35$ (no boot), $90 \times 16 \times 9$
Approx Weight (g)	35	50	65

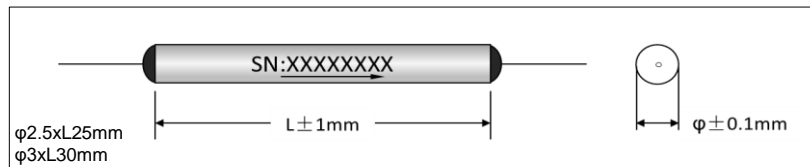
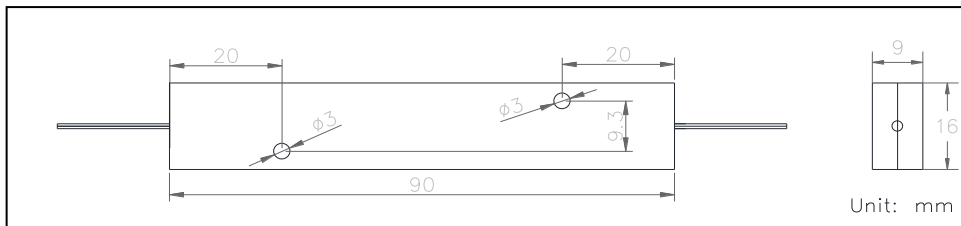
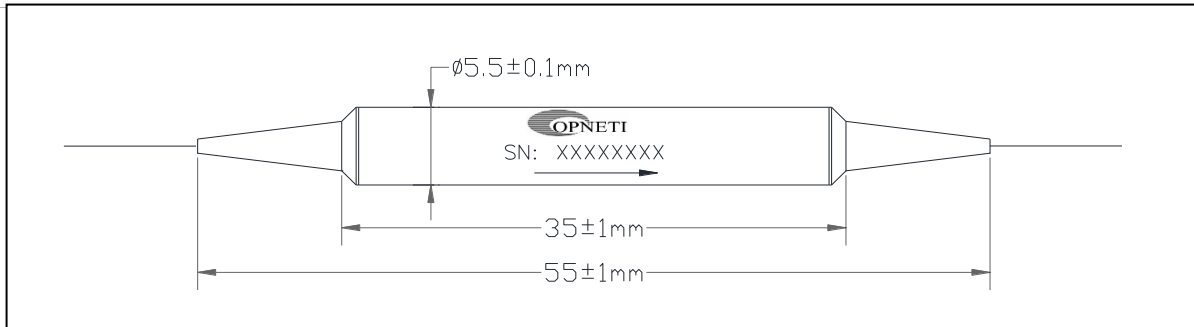

Ordering Information

PMIS- ①-②②②②-③-④④④-⑤⑤⑤-⑥-⑦⑦

①	Type	S=Single Stage; D=Dual Stage;
②	Wavelength	1850;
③	Axis Alignment	F=Fast Axis Blocked; B=Both Axes Working;
④	Pigtail Type	250=250μm Fiber; 900=900μm Loose Tube; 2000=2mm Loose Cable; 3000=3mm Loose Cable;
⑤	Fiber Type	P15=PM1550; P19=PM1950; P20=PM2000;
⑥	Fiber Length	1=1m; XX=other;
⑦	Connector	NE=None; FA=FC/APC; FC=FC/UPC; SA=SC/APC; SC=SC/UPC; LC=LC/UPC; XX=Others;